

Installation Instructions for ASHCROFT® Model 1134 Differential Pressure Gauge/Switch

ASHCROFT®

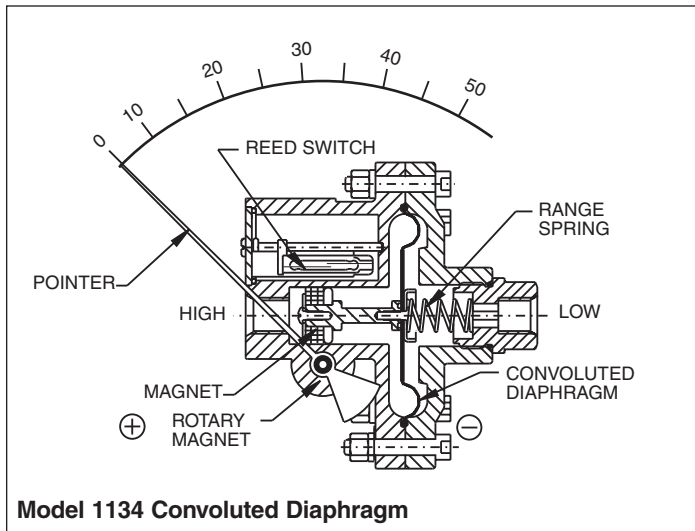

DIFFERENTIAL PRESSURE GAUGE/SWITCH

For efficient working of your gauge, please read all instructions carefully before attempting to install.

Caution: Do not exceed maximum operating pressure given on the gauge label. Check fluid compatibility with wetted parts before use. Do not mount the gauge at locations where the gauge is subjected to vibrations.

Operating principle: High and Low pressures are separated by a sensor assembly consisting of a magnet, diaphragm and a range spring. The difference in pressure causes the sensor assembly to move in proportion to the change against a range spring. A rotary magnet, located in a separate body compartment and isolated from the acting pressures is rotated by magnetic coupling as per the linear movement of the sensor assembly. A pointer attached to the rotary magnet indicates differential pressure on the dial. (see diagram)

Note: These instruments are calibrated to give $\pm 2\%$ full scale accuracy on ascending readings.

Installation: For better performance the gauge should be mounted horizontally with the dial vertical. Depressurize the system and connect the high and low pressure lines of your system to the "High" (+) and "Low" (-) ports of the gauge, respectively.

High pressure: Connect tubing from source of high pressure to either of the two high pressure ports. Plug the port which is not used.

Low pressure: Connect tubing from source of low pressure to either of the two low pressure ports. Plug the port which is not used.

The instrument is now ready for operation. Apply "High" and "Low" pressures simultaneously, to avoid damage to the internal parts.

The model 1134 consists of a convoluted diaphragm to sense the pressure difference. It can withstand maximum operating pressure up to 35 psi/2.4 bar and temperature up to 140°C/60°F maximum for all ranges.

If pressure exceeds the rated maximum pressure, "O" rings and diaphragm inside the pressure chamber, will be damaged. If maximum operating pressure is within the allowable limit of 35 psi/2.4 bar, but the differential pressure exceeds instrument range, there will be no damage to the instrument. The pointer will only go the extreme right end of the scale.

The pointer will always be in the zero box with no pressure applied. Calibration or adjustment of pointer is not recommended unless the pointer is outside the zero box.

For zero calibration adjustments, turn the pre-compression screw (located in the high (+) sideport) clockwise or counter clockwise. Do not attempt to open/repair the gauge. This screw is located in the high side connection.

Precautions: Do not connect "High" and "Low" ports to wrong pipe ends. Do not subject the instrument to excessive vibration. Field repairs are not recommended, because if not reassembled properly calibration will be affected.

Standard accessories: Two 1/8 NPT (M) adapters for tube connection to inline or back ports. Two 1/8 NPT (M) plugs to plug the ports not in use. Three screws, each of M3 x 4 and M3 x 20 for flush mounting along with three flush mounting clamps. See reverse for more information.

For surface mounting (option): For surface mounting, a surface mounting plate with two spacers is supplied. See reverse for more information.

Troubleshooting: If the gauge does not show reading or shows incorrect reading.

- See that the unused ports are properly plugged.
- Pressure tubing is connected without leaks, blocks or twists.
- Installation done as per the recommended procedure.
- Foreign/magnetic particle have entered the sensing chamber.
- If problem is not resolved by referring to the information above, contact your supplier of Ashcroft® gauges.

Installation Instructions for ASHCROFT® Model 1134 Differential Pressure Gauge/Switch



SWITCH SETTING

Please follow these instructions when your differential pressure instruments are supplied with switch.

Switch operation: Optional, reed switches are located adjacent to the pressure chamber and are activated by the magnetic field of the sensor assembly.

Caution: Supply should not exceed switch rating. For higher supply, use of relay circuit is recommended.

Switch adjustment: Switch adjustment screw is located on plastic cover. Rotate the screw counter-clockwise to increase the setpoint and clockwise to decrease the setpoint. One or two trials may be necessary to attain the exact setpoint.

Above procedure to be followed by putting the instrument on test bench or while in actual service.

Note: Instrument and switch has IP65 protection.

SWITCH SETTING

View from high pressure side



Increased setpoint
counter clockwise

Decreased setpoint
clockwise

SPST SWITCH (optional)

Specifications

Contact Rating : 10 VA ac (rms) or dc (max)
Switching Current : 0.5 Amp ac (rms) or dc (max)
Switch Voltage : 100 Vac (rms) or dc (max)

One SPST switch Reed Switches and DIN Plug Connection

View of socket for supply connections

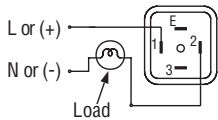

View of plug after removing the socket

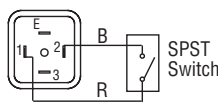

Two SPST switches Reed Switches and DIN Plug Connection

View of socket for supply connections

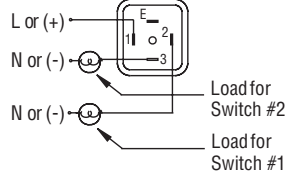

View of plug after removing the socket

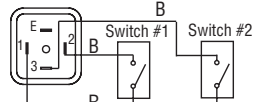

FLUSH MOUNTING

Flush mounting kit contains three each of M3X4 and M3X20 screws with three flush mounting clamps.

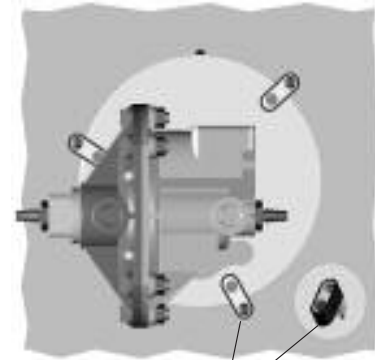

Panel cutout - 115 mm / 4.52"

Flush mounting
clamp

Model 1134 Flush Mounting Bracket

SPDT SWITCH (optional)

Specifications

Contact Rating : 3 VA ac (rms) or dc (max)
Switching Current : 0.3 Amp ac (rms) or dc (max)
Switch Voltage : 30 Vac (rms) or dc (max)

One SPDT switch Reed Switches and DIN Plug Connection

View of socket for supply connections

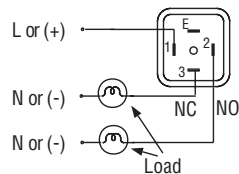

View of plug after removing the socket

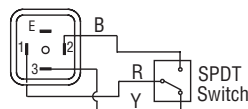

R = Red; B = Black; Y = Yellow; L = Live or + Supply; N = Neutral or - Supply.

SURFACE MOUNTING (OPTIONAL)

Surface mounting plate and fasteners supplied with option.

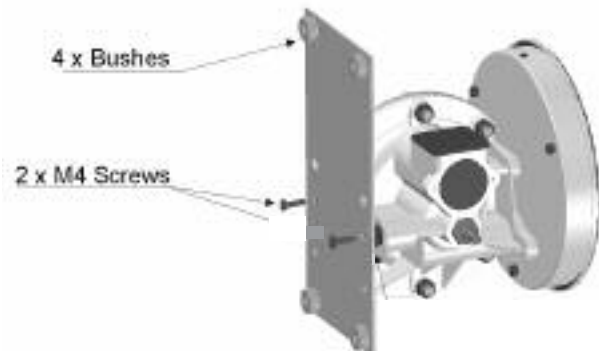

Model 1134 DGC Surface Mounting Option

Seal back ports with metal plugs supplied and clamp the plate with two M4X10 screws on tapped holes of plugs.