

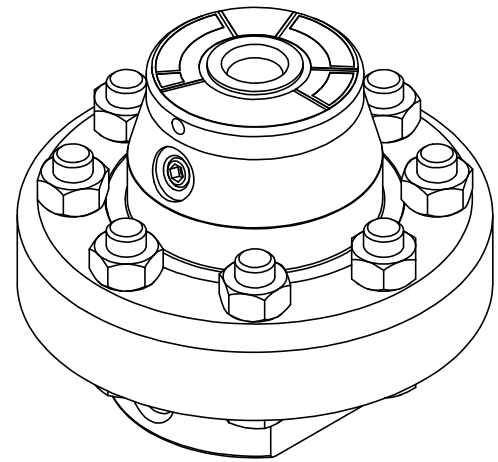

This drawing includes confidential information which is the property of ASHCROFT INC. This copy is loaned for a specific purpose, with the understanding that it will not be reproduced or used for any other purpose or disclosed to others, and it will be returned on demand.

**ASHCROFT** INC.

250 EAST MAIN STREET  
STRATFORD, CT 06614

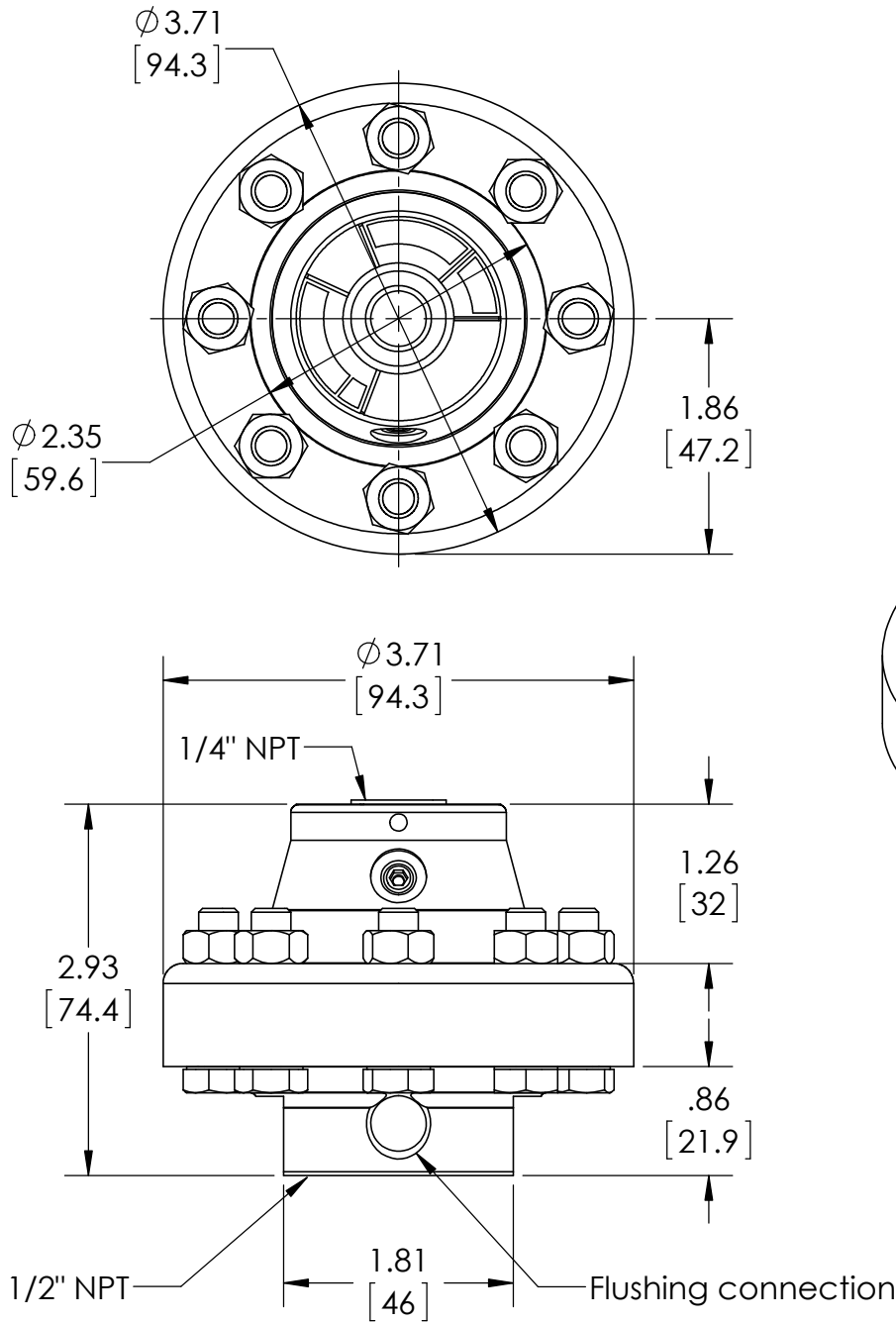

DIMENSIONS IN [ ] ARE MILLIMETERS

REV.	ECO	DESCRIPTION	BY	DATE
A	0005001	RELEASED GENERAL DIMS.	MJS	7/20/2010

This print certified correct for		General Dimensions			
Customer's Name		TYPE: 101, 201, 301			
Customer's Order No.		PROCESS CONN: 1/2" - INSTRUMENT CONN: 1/4" NPT			
Ashcroft Order No.		THREADED DIAPHRAGM SEAL W/ FLUSHING CONN.			
Certified by		Drawn MJS	Date 7/20/10	Date of Issue	
Date		Checked	Date	SHEET-1	Rev.
		Approved	Date	<b>70A3287</b>	<b>A</b>